

## Product description

### General overview

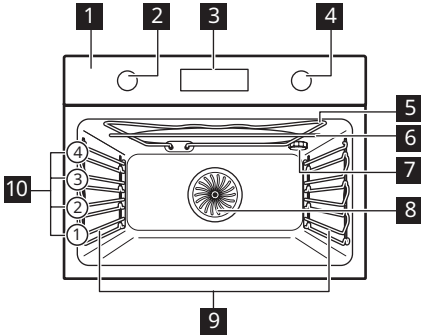

- 1 Control panel
- 2 Knob for the heating functions
- 3 Display
- 4 Control knob
- 5 Heating element
- 6 Microwave generator
- 7 Lamp
- 8 Fan
- 9 Shelf support, removable
- 10 Shelf positions

## Control panel

### Control panel overview

Select a heating function to turn on the appliance. Turn the knob for the heating functions to the off position to turn the appliance off.

	Press to set: Clock functions.
	Press to set: Fast Heat Up.
	Press to turn on or to turn off the oven lamp.
	Press to set: Microwave power.
OK	Press to confirm the selection.

### Display indicators

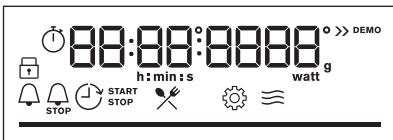





Display with key functions.

	The appliance is locked.
	Enter the menu and select the icon to open: Assisted Cooking.
	Enter the menu and select the icon to open: Settings
	Microwave function is turned on.
	Minute minder is turned on.
	End time is turned on.
	Time Delay is turned on.
	Uptimer is turned on.
	The bar is fully red when the appliance reaches the set temperature.

Daily use

Heating functions

Standard heating functions



	<b>True Fan Cooking:</b> Even baking, tenderness, drying
	<b>Conventional Cooking:</b> Traditional baking
	<b>Pizza Function:</b> Baking pizza
	<b>Turbo Grilling:</b> Roasting meat, browning
	<b>Menu:</b> To enter the menu.

Microwave combi functions

	<b>Turbo Grilling + MW:</b> Roasting large pieces, making gratins
---	---

	<b>True Fan Cooking + MW:</b> Baking
---	--------------------------------------

Microwave functions

	<b>Defrost:</b> Defrosting meat, fish, cakes, power range: 100 - 200 W
	<b>Reheat:</b> Heating up pre-prepared meals and delicate food, power range: 300 - 700 W
	<b>Microwave:</b> Heating up, cooking, power range: 100 - 1000 W

True Fan Cooking, Conventional Cooking: When you set the temperature below 80 °C the lamp automatically turns off after 30 sec.

Assisted Cooking

The display shows **F** and a **number** of the function that you can check in the table.

	Heating function	Application
<b>1</b>	Grill	To grill thin pieces of food and to toast bread.
<b>2</b>	Bottom Heat	To bake cakes with crispy bottom and to preserve food.
<b>3</b>	Frozen Foods	To make convenience food (e.g., french fries, potato wedges or spring rolls) crispy.
<b>4</b>	Conventional Cooking + MW	Baking and roasting food on one shelf position. The function with MW boost.
<b>5</b>	Grill + MW	To cook food in a short time and to brown it. The function with MW boost.

The display shows **P** and a **number** of the dish that you can check in the table.

<b>1</b>	Roast Beef, rare
<b>2</b>	Roast Beef, medium
<b>3</b>	Roast Beef, well done
<b>4</b>	Steak, medium
<b>5</b>	Beef roast / braised
<b>6</b>	Roast Beef, rare LTC*
<b>7</b>	Roast Beef, medium LTC*
<b>8</b>	Roast Beef, well done LTC*

<b>9</b>	Fillet, rare LTC*
<b>10</b>	Fillet, medium LTC*
<b>11</b>	Fillet, done LTC*
<b>12</b>	Veal roast
<b>13</b>	Pork roast neck or shoulder
<b>14</b>	Pulled pork LTC*
<b>15</b>	Loin, fresh
<b>16</b>	Spare Ribs
<b>17</b>	Lamb leg with bones

18	Whole chicken
19	Half chicken
20	Chicken breast
21	Chicken legs, fresh
22	Duck, whole
23	Goose, breast
24	Meat loaf
25	Whole fish, grilled
26	Fish fillet
27	Cheesecake
28	Apple cake
29	Apple tart
30	Apple pie
31	Brownies
32	Chocolate muffins
33	Loaf cake
34	Baked potatoes
35	Wedges
36	Grilled mixed vegetables
37	Croquets, frozen
38	Pommes, frozen
39	Meat / vegetable lasagna with dry noodle plates
40	Potato gratin
41	Pizza fresh, thin

42	Pizza fresh, thick
43	Quiche
44	Baguette / Ciabatta / White bread
45	All grain / rye / dark bread all grain in loaf pan

\*LTC - Low Temperature Cooking

**Changing settings**

- ☰ - select to enter Menu.
- ⚙️ - select to enter Settings. Press OK.
- Turn the knob to select the setting. Press OK.
- Adjust the value. Press OK.  
Turn the knob for the heating functions to the off position to exit the Menu.





**Menu: Settings**

The display shows **0** and a **number** of the setting that you can check in the table.

	Setting	Value
1	Time of day	Change
2	Display brightness	1 - 5
3	Key tones	1 - Beep, 2 - Click, 3 - Sound off
4	Buzzer volume	1 - 4
5	Uptimer	On / Off
6	Light	On / Off
7	Demo mode	Activation code: 2468
8	Software version	Check
9	Reset all settings	Yes / No

**Microwave suitable cookware and materials**

For the microwave use only suitable cookware and materials. Use below table as a reference. Check the cookware / material specification before use.

Cookware / Material		 	 
Ovenproof glass and porcelain with no metal components, e.g. heat-proof glass	✓	✓	✓
Non-ovenproof glass and porcelain without any silver, gold, platinum or other metal decorations	✓	x	x
Glass and glass ceramic made of oven-proof / frost-proof material	✓	✓	✓
Ovenproof ceramic and earthenware without any quartz or metal components and glazes which contain metal	✓	✓	✓
Ceramic, porcelain and earthenware with unglazed bottom or with small holes, e.g. on handles	x	x	x
Heat-resistant plastic up to 200 °C	✓	✓	x
Cardboard, paper	✓	x	x
Clingfilm	✓	x	x
Microwave clingfilm	✓	✓	x
Roasting dishes made of metal, e.g. enamel, cast iron	x	x	x
Baking tins, black lacquer or silicon-coated	x	x	x
Baking tray	x	x	x
Wire shelf	x	x	✓
Microwave glass bottom plate	✓	✓	x
Cookware for microwave use, e.g. crisp pan	x	✓	x

## Troubleshooting

If you encounter an issue with your appliance, check "Troubleshooting" chapter

in the full version of the User Manual available on: [www.ikea.com](http://www.ikea.com).

## Technical data

Dimensions (internal)	Width Height Depth	480 mm 217 mm 411 mm
Usable volumes	43 l	
Area of baking tray	1438 cm <sup>2</sup>	
Top heating element	- W	
Bottom heating element	1000 W	
Grill	1900 W	
Ring	1650 W	
Total rating	3000 W	

Voltage	220 - 240 V
Frequency	50 Hz
Number of functions	9